

Wheel Torque Transducers

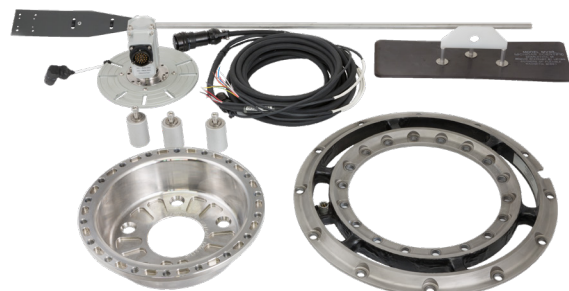

WHEEL TORQUE TRANSDUCER SPECIFICATIONS

Model	Application	Rim Size	High Resolution	Maximum Static Weight (Fz)	Full Scale Measurable Load	Max Torque Capacity	Nonlinearity (% of Full Scale Output)	Configuration
TW9.5	ATV & Small Vehicle	≥ 10 in		1,000 lb (455 kg)	4,000 lbf-ft (5.4 kN·m)	4,000 lbf-ft (5.4 kN·m)	0.10%	Light Duty Single Wheel
TW10.8	Car, SUV, & Light Truck	≥ 13 in		1,600 lb (725 kg)	3,000 lbf-ft (4.0 kN·m)	3,000 lbf-ft (4.0 kN·m)	0.10%	Medium Duty Single Wheel
TW12.8	Small Automobile to Light Truck	≥ 12 in		2,250 lb (1,000 kg)	6,000 lbf-ft (8.1 kN·m)	6,000 lbf-ft (8.1 kN·m)	0.10%	Medium Duty Single Wheel
TW12.8ER	Small Automobile to Light Truck	≥ 12 in		2,250 lb (1,000 kg)	4,000 lbf-ft (5.4 kN·m)	4,000 lbf-ft (5.4 kN·m)	0.10%	Medium Duty Single Wheel
TW12.8 HRMS175	Small Automobile to Light Truck	≥ 12 in	•	2,250 lb (1,000 kg)	175 lbf-ft (237 N·m)	6,000 lbf-ft (8.1 kN·m)	0.10%	Medium Duty Single Wheel
TW12.8 HRMS800	Small Automobile to Light Truck	≥ 12 in	•	2,250 lb (1,000 kg)	800 lbf-ft (1.0 kN·m)	6,000 lbf-ft (8.1 kN·m)	0.10%	Medium Duty Single Wheel
WT10	Small Automobile to Light Truck	≥ 12 in		2,900 lb (1,320 kg)	7,700 lbf-ft (10.5 kN·m)	7,700 lbf-ft (10.5 kN·m)	0.10%	Medium Duty Single Wheel
TWHR2000	Class 8 truck, Agricultural & Construction Equipment	≥ 22.5 in	•	11,000 lb (5,000 kg)	2,000 lbf-ft (2.7 kN·m)	20,000 lbf-ft (27 kN·m)	0.15%	Heavy Duty Single or Dual Wheel
TW15.0	Light to Medium Duty Truck	≥ 15 in		2,250 lb (1,000 kg)	7,000 lbf-ft (9.5 kN·m)	7,000 lbf-ft (9.5 kN·m)	0.10%	Medium Duty Single Wheel
WT20	Light and Heavy Duty Truck, Van, & SUV	≥ 16 in		4,000 lb (1,800 kg)	14,750 lbf-ft (20 kN·m)	14,750 lbf-ft (20 kN·m)	0.15%	Medium Duty Single or Dual Wheel
WT30	Medium Trucks, Off-Road Equipment, & Large Forklifts	≥ 15 in		6,000 lb (2,720 kg)	22,000 lbf-ft (30 kN·m)	22,000 lbf-ft (30 kN·m)	0.10%	Medium Duty Single or Dual Wheel
TW-2T-50K	Class 8 Truck, Agricultural & Construction Equipment	≥ 19.5 in		10,000 lb (4,500 kg)	50,000 lbf-ft (67 kN·m)	50,000 lbf-ft (67 kN·m)	1.0%	Heavy Duty Single or Dual Wheel
TW-2T-60K-S	Class 8 Truck, Agricultural & Construction Equipment	≥ 19.5 in		13,480 lb (6,100 kg)	60,000 lbf-ft (81 kN·m)	60,000 lbf-ft (81 kN·m)	1.0%	Heavy Duty Single or Dual Wheel





Wheel Torque Transducers gather data that can be used in braking systems, vehicle stability, and driveline development. Data from these tests are valuable in determining where energy is lost within the system, which allows for adjustments to be made to improve the efficiency of the system and the vehicle.



Severe (ABS) Brake Stops

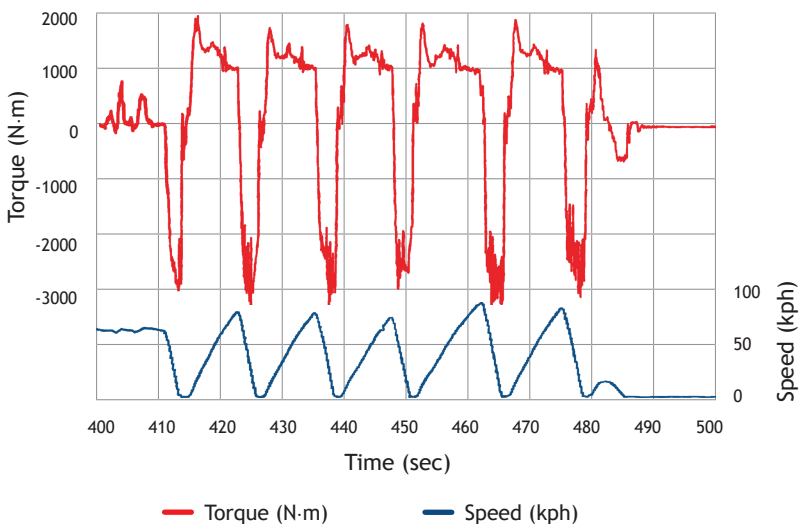

HIGH RESOLUTION WHEEL TORQUE TRANSDUCERS

With Michigan Scientific High Resolution Wheel Torque Transducers it is possible to measure aerodynamic drag, brake drag, tire rolling resistance, and bearing seal drag during on-road testing. Model *TW12.8HRMS175* can be used to test cars and SUVs. It resolves 0.1 N·m, while model *TWHR2000* can be used to test commercial trucks and resolves 0.8 N·m.

High Resolution Wheel Torque Transducers are commonly used for on-road measurement of chassis system losses which influence fuel economy. It is the ideal tool for fuel regulation testing.

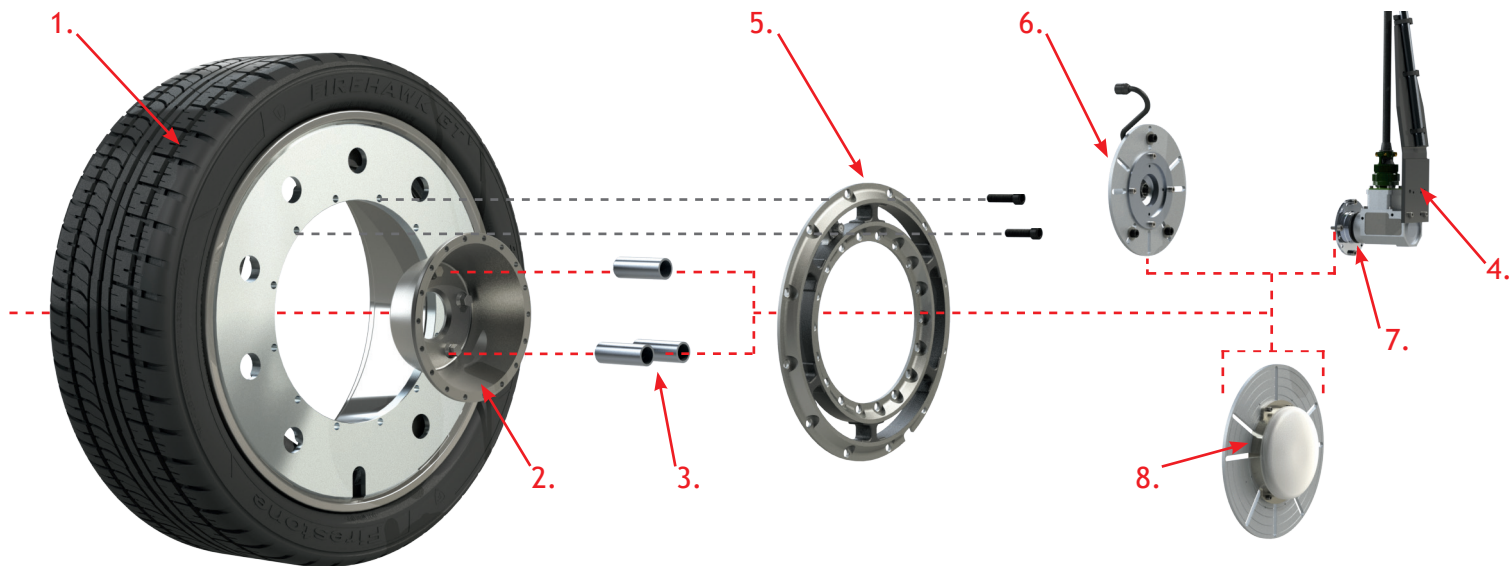

1. RIM ADAPTER

Modified production wheel or custom machined wheel for mounting transducer to wheel

2. HUB ADAPTER

Custom adapter that mounts transducer and rim adapter assembly to production vehicle hub

3. QUICK CONNECT LUG NUT COLLETS

Quick Connect Lug Nut Collets mount to standard lug nuts

4. STATOR RESTRAINING ROD

Stabilizes the stator of the slip ring assembly relative to the vehicle for angle reference

5. WHEEL TORQUE TRANSDUCER

Measures drive and braking torque at vehicle corner

SIGNAL CONDITIONING

6. Wheel Instrumentation Package (WIP)

Mounts to a variety of wheel lug bolt patterns and conditions signals from the transducer and provides (optional) thermocouple signal conditioning

7. Slip Ring Assembly

Measures rotational velocity and angular position while completing electrical connection between rotational and stationary components

OR

8. Telemetry Data Transmission Electronics

Wireless signal transfer to receivers located inside vehicle
Does not provide rotational velocity or angular position

FEATURES:

- Weatherproof
- High Accuracy Encoder
- Slip Ring Assembly That Provides Rotational Velocity and Angular Position Data
- Precision Strain Gauge and Optional Thermocouple Spinning Amplifiers
- 3 Year Warranty on Transducers

Michigan Scientific Corporation designs and manufactures highly sensitive Wheel Torque Transducers to measure drive and braking torque. The transducers are attached to adapters that duplicate the critical dimensions of the original rim and hub. Due to the high strength material and weatherproof sealing, the assemblies can be used under normal driving conditions.

Related Products

LOW PROFILE BRAKE PEDAL FORCE TRANSDUCER 2

The Low Profile Brake Pedal Force Transducer 2 (BPFT2) is a precision strain gauge load cell. It attaches directly onto a vehicle's pedal quickly and securely by removing the rubber pad and tightening the single retaining bolt. Designed to accommodate most cars, the low profile closely duplicates the shape and feel of production brake pedals, while adding minimal height and weight. It features high accuracy for both on-center and off-center loading.



FLEXPLATE TRANSDUCER

The Flexplate Telemetry Torque Measurement System measures engine torque with a custom transducer installed between the engine and transmission. It is designed to take the place of a stock flexplate or flywheel without the need for any engine or transmission modifications. Three channel systems are available for torque, thrust, and temperature measurements. This allows for accurate and reliable benchmarking and vehicle efficiency analysis.

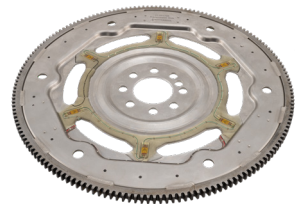

CLAMPING INDUCTION TELEMETRY

The Michigan Scientific Clamping Induction Telemetry (CIT) is a wireless, non-contact signal transmitter that easily mounts to shafts with a minimum diameter of one inch. Strain gauge signals are transmitted digitally with error checking to provide stable and accurate measurements. The small ruggedized housing is intended for hostile environments where vibration, extreme temperature, high acceleration, and when contaminants are present.



Additional Information

Accreditation and Certification

The design, manufacturing, and calibration process of the Michigan Scientific Corporation WTTs are ISO 9001:2015 certified. The WTT calibrations are ISO/IEC 17025:2017 accredited and all reference measurement equipment is traceable to the National Institute of Standards and Technology (NIST).

Calibration

All MSC Torque Transducers are calibrated on unique, patented transducer calibration machines. It is recommended that customers send their transducers to MSC for recalibration after first year of use, and every two years afterwards. MSC provides fast, in-house recalibration services for all of a transducer products.

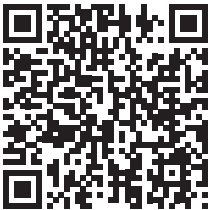
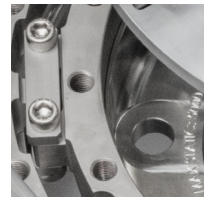
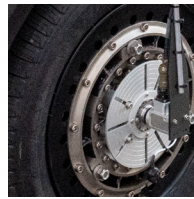
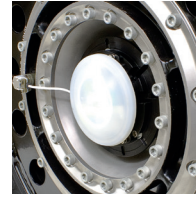
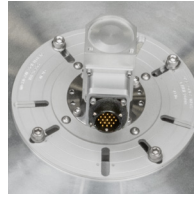

Michigan Scientific Corporation

www.michsci.com

8500 Ance Road
Charlevoix, MI 49720
Tel: 1-231-547-5511
Fax: 1-231-547-7070

321 East Huron Street
Milford, MI 48381
Tel: 1-248-685-3939
Fax: 1-248-685-5406

Details and specifications provided in this document are purely for informational purposes and are subject to alterations. No liability is accepted for errors or omissions.

©2024 Michigan Scientific Corporation

REV: February 1, 2024